

Marine Genset- CCFJ200J-WY

Gen-Set Specifications

GenSet Model	CCFJ200J-WY	
Power Factor	0.8-3 phase	
Frequency	Voltage	Prime
50Hz	400V	200kW
60Hz	440V	200kW



Standard Features

◆ Mechanical/Electronic governor	◆ DC24V Electric starter	◆ Dual-circulate water-cooled
◆ IP23	◆ H type insulation	◆ Shutoff electronic solenoid
◆ Instrument	◆ Common high pressure pipe	◆ CCS certification
◆ Spare Parts & Tools	◆ Documents	◆ Packaging: plywood
◆ Paralleling function	◆ Alternator anti-condensation	

Options

◇ Remote Control Panel	◇ Electric potentiometer	◇ Alternator winding temperature alarm
◇ Engine Heater (water & oil heater)		

Engine Specifications

Engine Make & Model	Weichai WP10CD264E200	WP10CD264E201
	(50HZ)	(60HZ)
Rated Speed	1500 rpm	1800rpm
Prime Power	240kW	
Bore & Stroke	126x130 mm	
Displacement	9.726	
Cylinder Number	6	
Fuel System	Mechanical Pump	
Governor Method	Mechanic	
Aspiration	Turbocharged and Aftercooled	
Starting Method	24V electric starter and battery charging alternator	

Alternator Specifications

Alternator Make	CSIEM	
Alternator Model	1FC2 284-4	1FC2 283-4
Bearing Nos	1	
Insulation Class	H	
Steady-State Volt Adjustable Rate	±2.5%	
IP class	IP23	
Winding Way	6	
Excitation Mod	Brushless	
Rated Power Factor	0.8	

Dimensions

	Length	Width	Height	Weight
CCFJ200J-WY	2542 mm	1000 mm	1572 mm	2059 kg

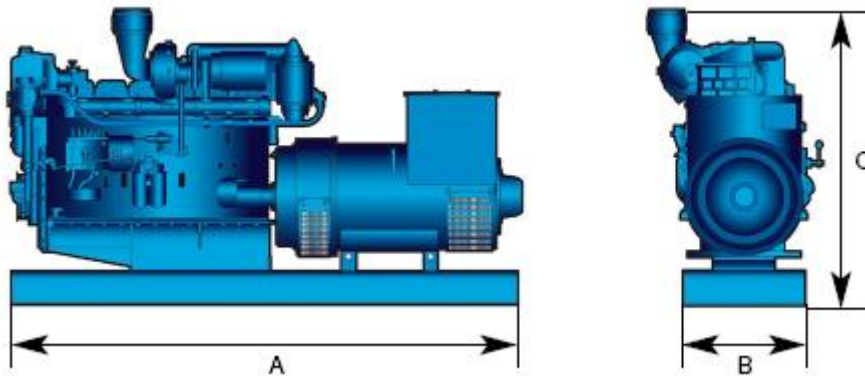

Sales Promises

Weichai Power provides a full line of brand new and high quality products. Each and every unit is strictly factory tested.

Warranty time: 1 year

Service and parts are available from Weichai Power or distributors in your location.

Distributed By:

Manufacturer: Weichai Power Co., Ltd
Address: 197 A, Fushou East Street, High-Tech
Development Zone, Weifang, China
www.weichai.com

