

Marine Genset- CCFJ800J-WP

Gen-Set Specifications

GenSet Model	CCFJ800J-WP	
Power Factor	0.8-3 phase	
Frequency	Voltage	Prime
50Hz	400V	800kW
60Hz	440V	800kW

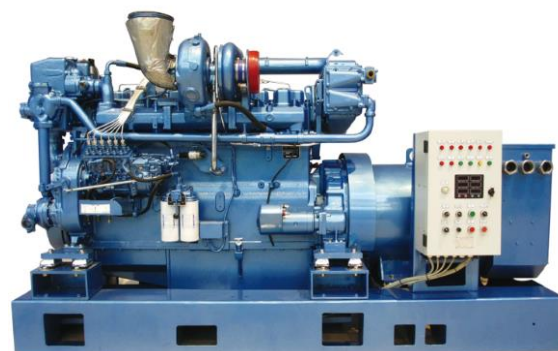

Standard Features

◆ Mechanical/Electronic governor	◆ DC24V Electric starter	◆ Dual-circulate water-cooled
◆ IP23	◆ H type insulation	◆ Shutoff electronic solenoid
◆ Instrument	◆ Common high pressure pipe	◆ CCS certification
◆ Spare Parts & Tools	◆ Documents	◆ Packaging: plywood
◆ Paralleling function	◆ Alternator anti-condensation	

Options

◇ Remote Control Panel	◇ Electric potentiometer	◇ Alternator winding temperature alarm
◇ Engine Heater (water & oil heater)		

Engine Specifications

Engine Make & Model	Weichai12M33CD968E200	12M33CD968E201
	(50HZ)	(60HZ)
Rated Speed	1500 rpm	1800 rpm
Prime Power	880 kW	
Bore & Stroke	150x185 mm	
Displacement	39.2	
Cylinder Number	12	
Fuel System	Mechanical Pump	
Governor Method	Electric	
Aspiration	Turbocharged and Aftercooled	
Starting Method	24V electric starter and battery charging alternator	

Alternator Specifications

Alternator Make	CSIEM	
Alternator Model	1FC2 454-4	1FC2 453-4
Bearing Nos	2	
Insulation Class	H	
Steady-State Volt Adjustable Rate	±2.5%	
IP class	IP23	
Winding Way	12	
Excitation Mod	Brushless	
Rated Power Factor	0.8	

Dimensions

	Length	Width	Height	Weight
CCFJ800J-WP (50Hz)	4070mm	1521mm	1927mm	7820±100kg
CCFJ800J-WP (60Hz)	3940mm	1521mm	1927mm	7370±100kg

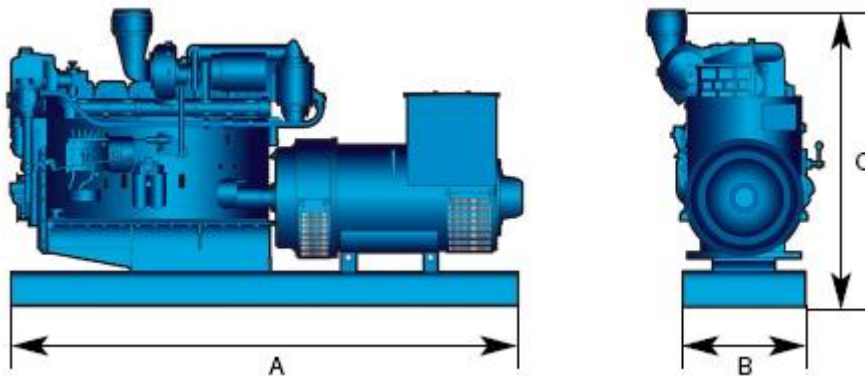

Sales Promises

Weichai Power provides a full line of brand new and high quality products. Each and every unit is strictly factory tested.

Warranty time: 1 year

Service and parts are available from Weichai Power or distributors in your location.

Distributed By:

Manufacturer: Weichai Power Co., Ltd
 Address: 197 A, Fushou East Street, High-Tech
 Development Zone, Weifang, China
www.weichai.com

